

Draft

# Operating Instruction Manual

**pH/Redox/ISE Meter  
TM 40**

**Oxygen Meter  
AM 40**

**Conductivity Meter  
LF 40**



1. Safety.....	4
2. Sockets .....	5
2.1 Battery .....	5
3. Button, Display, Menu structure, Password protection.....	6
3.1 Operation elements .....	6
4. Configuration the basic settings "General" .....	7
4.1 Configuration Backlight.....	7
4.2 Configuration pass word.....	8
4.3 Configuration clock .....	8
4.4 Configuration language .....	8
4.5 Configuration off time .....	8
4.6 Data logger .....	9
5. Info.....	10
6. Interface HMG USB.....	10
7. Maintenance, Disposal .....	10
8. TM 40.....	11
8.1 Application Fields TM 40 .....	11
8.2 Construction TM 40 .....	11
8.3 pH-Sensor EGA 142/TM 40 .....	11
8.4 Menu structure TM 40 .....	11
8.5 Calibration pH.....	14
8.5.1 Data input .....	14
8.5.2 Settings of the temperature offset .....	14
8.5.3 Two-point-Calibration "two point" .....	14
8.5.4 Automatic Calibration .....	15
8.5.5 Calibration error.....	15
8.6 Calibration Redox .....	15
8.6.1 Data input .....	15
8.6.2 Setting of the temperature offset .....	15
8.7 Calibration ISE.....	15
8.7.1 Data input .....	15
8.7.2 Settings of the temperature offset .....	16
8.7.3 Two-point Calibration „Two point“ .....	16
8.8 Configuration TM 40.....	16
8.8.1 Configuration of the fix temperature .....	17
8.8.2 Configuration of the sensor type .....	17
9. AM 40 .....	17
9.1 Application Fields AM 40.....	17
9.2 Construction AM 40.....	17
9.3 Dissolved Oxygen Sensor MF 41-N/AM 40.....	18
9.4 Menu structure AM 40 .....	18
9.5 Calibration oxygen.....	19

9.5.1	Data input .....	20
9.5.2	Settings of the Temperature Offset .....	20
9.5.3	Single-Point Calibration „one point“ .....	20
9.5.4	Automatic Calibration .....	20
9.5.5	Calibration error .....	21
9.6	Configuration AM 40 .....	21
9.6.1	Configuration of the fix temperature .....	21
9.6.2	Configuration of the main value .....	21
10.	LF 40 .....	22
10.1	Application Fields LF 40 .....	22
10.2	Construction LF 40 .....	22
10.3	Conductivity Sensor LTC 0,35/LF 40 .....	22
10.4	Menu structure LF 40 .....	22
10.5	Calibration conductivity .....	23
10.5.1	Data input .....	24
10.5.2	Settings of the temperature offset .....	24
10.5.3	One-point-Calibration „one point“ .....	25
10.5.4	Automatic calibration „Automatic“ .....	25
10.5.5	Calibration error .....	25
10.6	Configuration .....	25
10.6.1	Configuration of the fix temperature .....	25
10.6.2	Configuration of the measuring range „meas. range“ .....	26
11.	Specifications .....	26
12.	Delivery volume .....	27
13.	Accessories .....	27

# 1. Safety



This Operating Instructions Manual contains fundamental information that should be observed in connection with the installation, start-up, operation and maintenance of the instrument in connection with the sensor. Therefore, it is absolutely vital for the user to read this manual completely prior to working with it.

The symbol  "General Warning" indicates special warnings in the manual.

## User qualification



The meter has been designed for analytical measurements. It is assumed that the user/operator and the maintenance personnel have the proper professional skills and experience to know the specific properties of analytical measuring systems, master the safe handling of chemicals, for example, in the maintenance of electrodes/sensors, and can assess any dangers and risks resulting thereof. The user must ensure that the national legislation and procedures concerning the maintenance of industrial health and safety standards, the accident preventions and the handling of chemicals are observed.

## Installation and getting started



The perfect functioning and operational safety of the instrument can only be maintained under the climatic conditions specified in the section "Specification" of this manual. When the instrument is moved from cold to warm surroundings, condensate may occur and interfere with the functioning of the instrument. In such case, the user should wait until the temperature of the instrument has adapted to the ambient temperature before using the instrument again.

Use the sensor and interface cables recommended by the manufacturer only. For the sensors and accessories, the instructions and regulations given in the respective operating instructions manuals and specification sheets will apply. The instrument can only be operated with the battery specified in the section "Specification".

Be careful when connecting other instruments (e.g. via interface). Connections with external instruments may cause not permissible potentials inside the instrument (e.g. connections between GND and earth). These potentials may result in operational influences or malfunctions in the instrument itself or the external devices connected.

## Proper usage



The meter and the sensor are intended for measuring and documentation of analysis parameters. Taking into consideration the "Specification" paragraph, operating and using the unit for this application is the proper usage. Any application beyond this and individual modifications or extensions are improper and will lead to loss of entitlement to the warranty. When connecting the unit with electro-chemical sensors, always take into account their life and natural wear as this may result in malfunctioning of the measuring system and the regulation or control associated therewith. The user must take suitable measures to limit harmful effects of such malfunctioning.

## General safety instructions



The complete meter has been manufactured and tested in accordance with the relevant guidelines and standards for electronic measuring equipment. It has left the factory in technically unobjectionable condition.

The perfect functioning and operational safety of the instrument and the accompanying components will only be ensured if the user observes the normal safety precautions as well as the specific safety guidelines stated in the present manual and in the relevant operating instruction manuals of the components contain replaceable components (exception of the battery) and must be opened for repair by proprietary workshops only. If there is reason to assume that the instrument can no longer be employed without a risk, it must be set aside and appropriately marked to prevent further use. The safety of the user may be endangered, e.g. if the instrument or one of its components:

- shows visible damage
- no longer operates as specified
- has been stored over a longer period under unsuitable conditions
- has been subjected to difficult conditions during transport

If in doubt, please contact your supplier and send back the instrument to the manufacturer for repair and maintenance.

## 2. Sockets

2 sockets for connecting the sensor and the "Interface HMG USB" are located on the front side of the instrument. Please use only the delivered original cable for the interface with the PC. For protecting the sockets against moisture and to avoid corrosion, the sensor should always be connected to the instrument and the "Interface HMG USB" socket should be sealed by means of the protection cap if it is not in use. The "Interface HMG USB" is not included in the delivery.



The measuring inputs must be potential-free and must have no connection to mains voltage potentials. All inputs must be operated with the appropriate sensors only. Connect directly from foreign signals is not allowed.

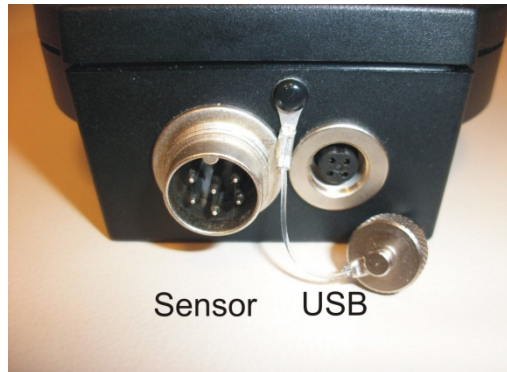

Cable Sockets

### 2.1 Battery

Please open the battery chamber on the back side of the instrument and insert the battery correctly into the chamber.



Battery Chamber



Please use only leak proof alkaline manganese batteries from the type **AA, IEC R6, LR6** only. After connecting and inserting the battery, please close the battery chamber carefully and correctly, to avoid moisture coming inside the device.

If the battery is in low condition, the device shows these with only 1 bar in battery indicator display. A change of the battery is recommended. If there is no bar in the display, the battery must be changed immediately.

 **Only for AM 40:**

**After changing battery or sensor please note the wait time before a new calibration. We recommend a new calibration after battery change, because the permanent polarisation of the sensor was interrupted by disconnecting the sensor from the battery.**



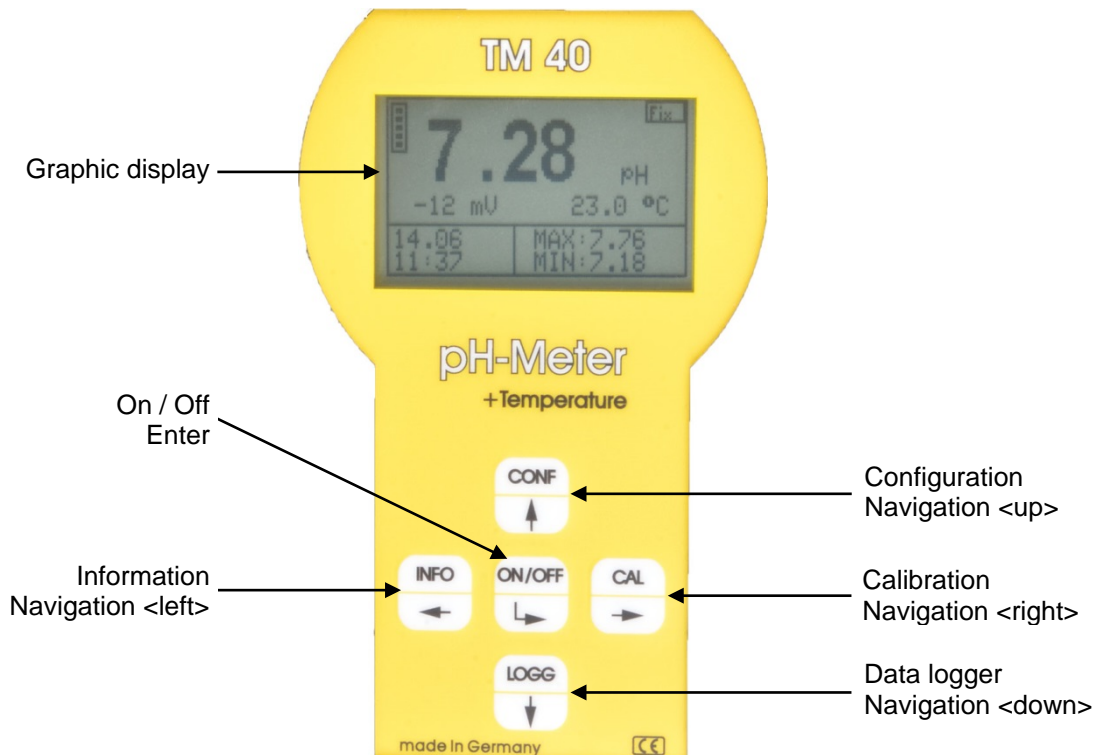

### 3. Button, Display, Menu structure, Password protection

#### 3.1 Operation elements

The instrument features easy operation by means of 5 buttons only and a plain text menu structure.



#### Button

					
Open a menu	Information	Configuration	Data logger	Calibration	On / Off
navigation in the menu	Cursor left	Cursor up	Cursor down	Cursor right	selection / ENTER
input / change values	Cursor left	position value +1	position value -1	Cursor right	confirm / save value

☞ By pressing the button “ON/OFF“ the meter switches on. The meter switches off either automatically after a preset time-out or by long (approximately 3 seconds) pressing the “ON/OFF“ button.

☞ Only for AM 40:

Also when the AM 40 is switched off, the connected O<sub>2</sub>-Sensor is supplied with the necessary polarisation voltage and so the system is directly after switching on always ready to measure.

## Display

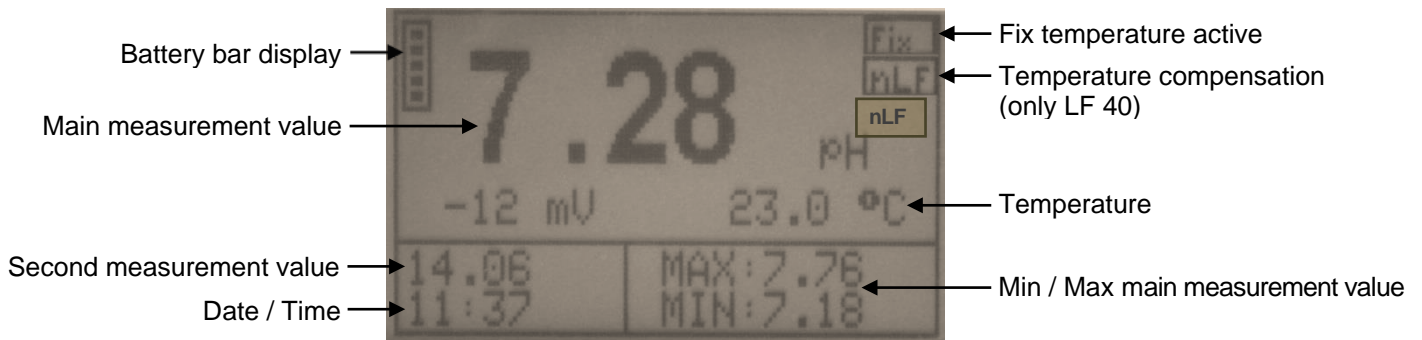

## Password protection

The calibration menu (CAL) and the configuration menu (CONF) are password-protected.

☞ The default password for opening these menus is **1**.

## 4. Configuration the basic settings “General”



Open with  + password the configuration menu.  
Select the menu item you would like to configure.



Backlight  
Password  
Clock  
Language  
Off time  
Back

### 4.1 Configuration Backlight



On the device the backlight for display can be switched on or off.

For configuration of the backlight do the following steps:

1. Open menu „general“
2. Select „Backlight“ disable/enable

Select the position you would like to use by using the buttons  or .





Press the  -button to accept and save the entry.

To cancel the input dialogue without saving the value press  + .



## 4.2 Configuration pass word

For configuration of the password do the following steps:

1. Open menu „general“
2. Select „Pass word“ and enter your new pass word
3. Retry the new pass word

Select the position you would like to change by using the buttons  or  and change with  or .





Press the  -button to accept and save the entry.

To cancel the input dialogue without saving the value press  + .



## 4.3 Configuration clock

For configuration of the clock do the following steps:

1. Open menu „general“
2. Select „clock“ and enter the time and date

Select the position you would like to change by using the buttons  or  and change with  or .



Press the  -button to accept and save the entry.

To cancel the input dialogue without saving the value press  + .



## 4.4 Configuration language

For configuration of the language do the following steps:

1. Open menu „general“
2. Select „language“ and enter the language

Select the position you would like to use by using the buttons  or .

Press the  -button to accept and save the entry.





To cancel the input dialogue without saving the value press  + .

## 4.5 Configuration off time



You can set the time when the meter switches off automatically. The data logger will continue to log, if it is set in para 4.6 (Data logger).

To configuration the off time do the following steps:

1. Open menu „general“
2. Select „off time“ and enter the time

Select the position you would like to change by using the buttons  or  and change with  or .

Press the  -button to accept and save the entry.

To cancel the input dialogue without saving the value press  + .







## 4.6 Data logger

The device has an integrated data logger with real-time clock. So it is possible to save the last about 4.000 data sets (date, time, main measurement value, second measurement value, temperature).



The saved data can be either displayed directly in the device display or transferred by the USB-interface.

To configuration the data logger do the following steps:

1. Open menu „general“
2. Enter the time interval in the menu item „ interval“

Select the position you would like to change by using the buttons  or  and change with  or .

Press the  -button to accept and save the entry.

To cancel the input dialogue without saving the value press  + .

### Data logger Automatic:

If the automatic is switched off, the logger logs only by switched on device. (please note also the off time)

If the automatic is switched on, the logger logs continue. (long time logging)

For correct logger function set the real time clock.

During view the logged data's the recording is stopped.

### Menu structure data logger

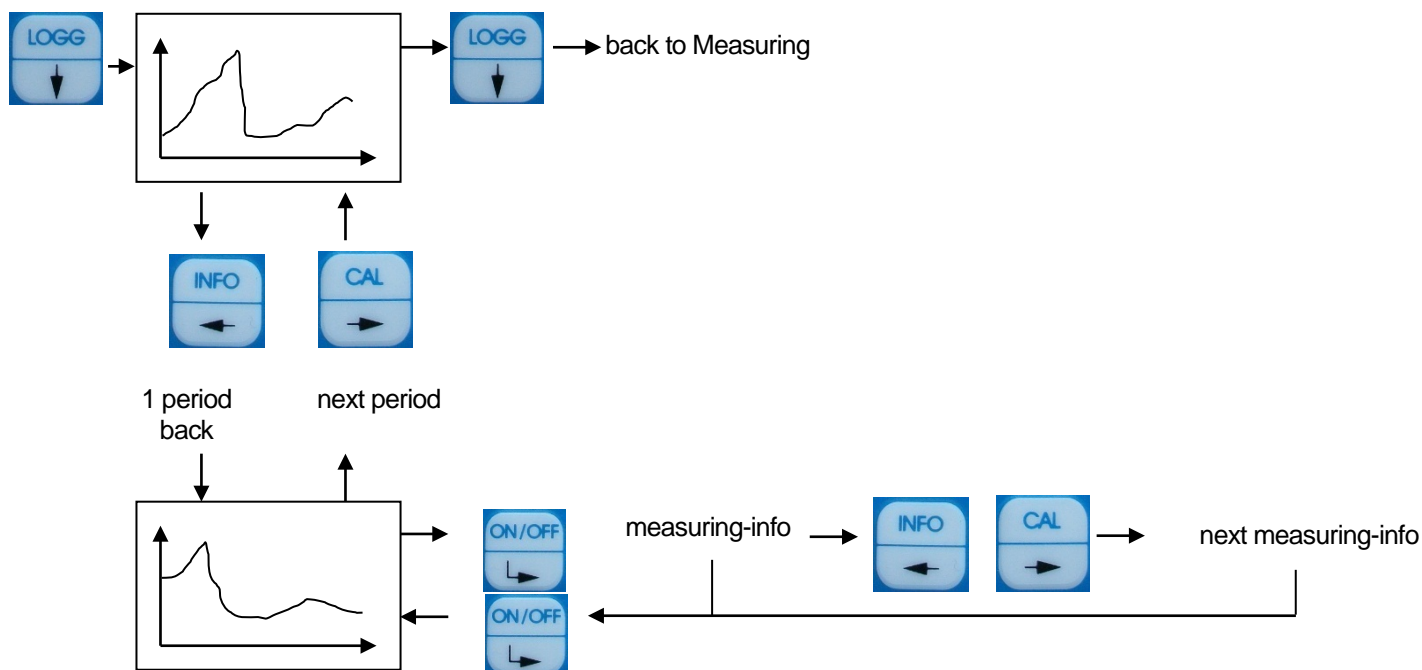

## 5. Info

### Menu structure Info

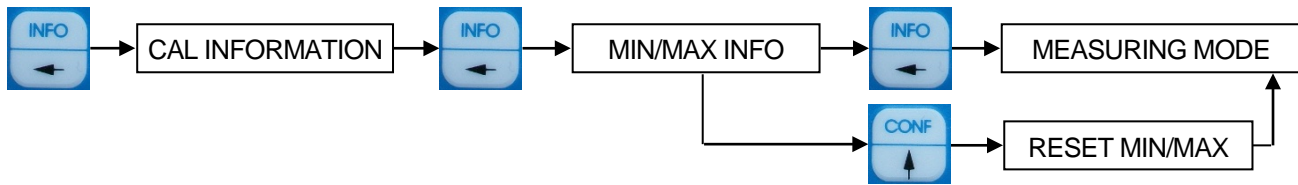

## 6. Interface HMG USB

For comfortable reading out of the data logger and configuration the device, a download of the software "DinModule" from <http://download.meinsberg.de/en/> is possible. To connected the pocked meter with a PC the as accessory available "Interface HMG USB" is needed.



## 7. Maintenance, Disposal



The meters are almost maintenance-free. In the case of dirtying it is only allowed to clean the outsides with a wet drapery. Cleaning with aggressive detergent which contains solvents (e. g. acetone) is forbidden. Otherwise damaging of the case and the plastic foil keyboard may occur. Do not use hard brushes or metal objects.

For maintenance and storage of the sensors / electrodes please observe the corresponding manuals of the sensors / electrodes.



Note:

This unit contains batteries. Batteries may only to the purpose-built recycling centers or via the retail outlet be disposed of.

Please send us the old measuring instruments and sensors for disposal. Sensortechnik Meinsberg GmbH takes it back free of charge and recycles/disposes the electronic scrap in a competent way. Do not dispose your old measuring instruments in household refuse, this is illegal. Please avoid the disposal at public collecting points.

## 8. TM 40

### 8.1 Application Fields TM 40

The pH/Redox/ISE Meter measures pH,/Redox and ISE-potential and combines the features for mobile application in the field with the precision and comfort of a laboratory meter with plain text structure menu, integrated data logging system and a rugged watertight IP 65 enclosure.

### 8.2 Construction TM 40

TM 40 / Set comes completely with the accompanying pH-Sensor EGA 142/TM 40 and accessories in a protective case. This combination operates in accordance with the standardized requirements for determination of pH; electrochemical probe method acc. EN ISO 10523:2012.

The instrument can be used in any situation where quickly and exactly pH/Redox/ISE-concentration and temperature should be measured. High measuring accuracy, processor-steered measuring value processing, watertight IP65 case and the versatility in connection with pH, Redox or ISE Sensors distinguish the TM 40.

The TM 40 has an automatic temperature compensation for the pH measurement as well as an adjustable reference temperature with measurements without temperature sensor. For calibration the automatic or manual calibration routine can be used.

By connection of a Redox sensor the TM 40 displays the measured Redox potential (to the Ag/AgCl-reference electrode) and the temperature-compensated calculation of the Redox potential referenced on the standard-hydrogen electrode to DIN 38404.

### 8.3 pH-Sensor EGA 142/TM 40

In the standard version the meter TM 40 comes with the pH / temperature combination electrode EGA 142/TM 40. This electrode features general application for laboratory and field. Its built-in temperature probe Pt 1000 enables simultaneous measurement of pH and temperature as well as automatic temperature compensated pH measurement. Obviously special electrodes (pH combination electrodes, redox combination electrodes or electrodes supplied from other manufacturers with BK plug) can be used in connection with TM 40. The isopotential point (25deg) of the used electrodes must be pH 7. Platinum combination electrodes with Ag/AgCl reference system with 3 mol/l KCl electrolyte are recommended for redox potential measurements (e. g. EMC 133/TM 40).

### 8.4 Menu structure TM 40

#### Menu structure Calibration

#### pH

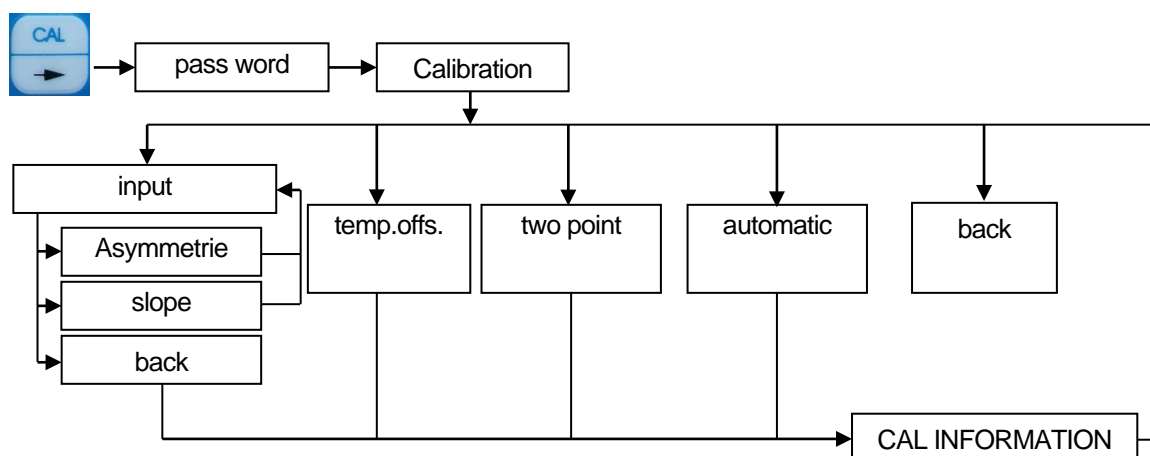

## Redox

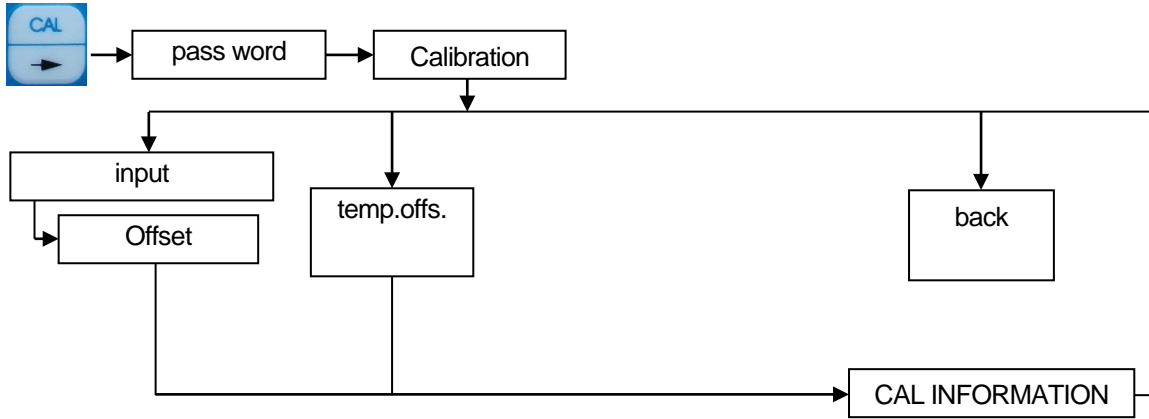

## ISE

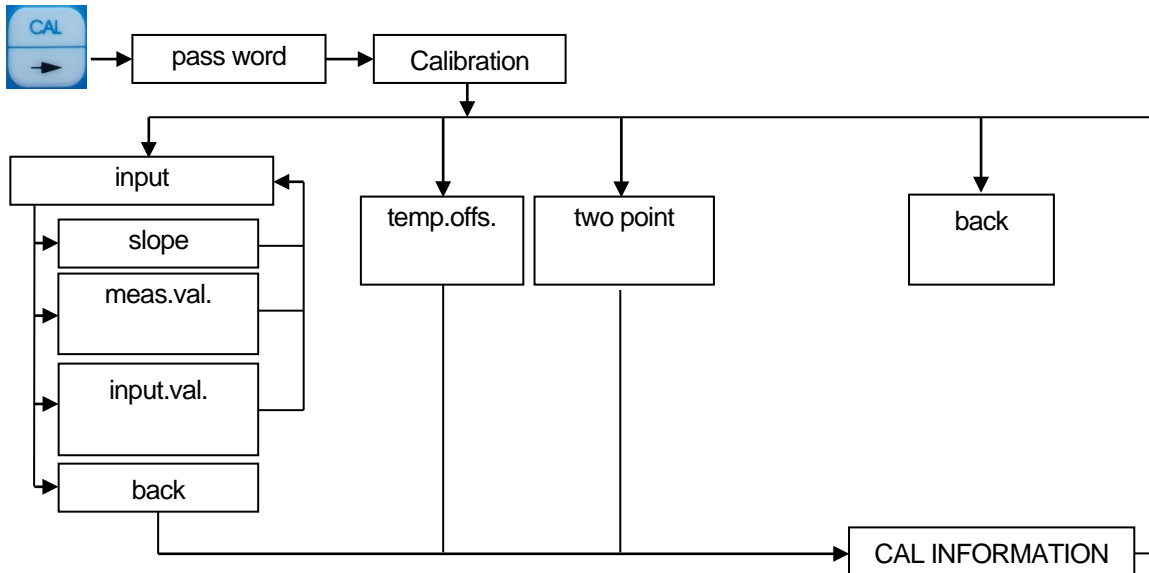

## Menu structure Configuration

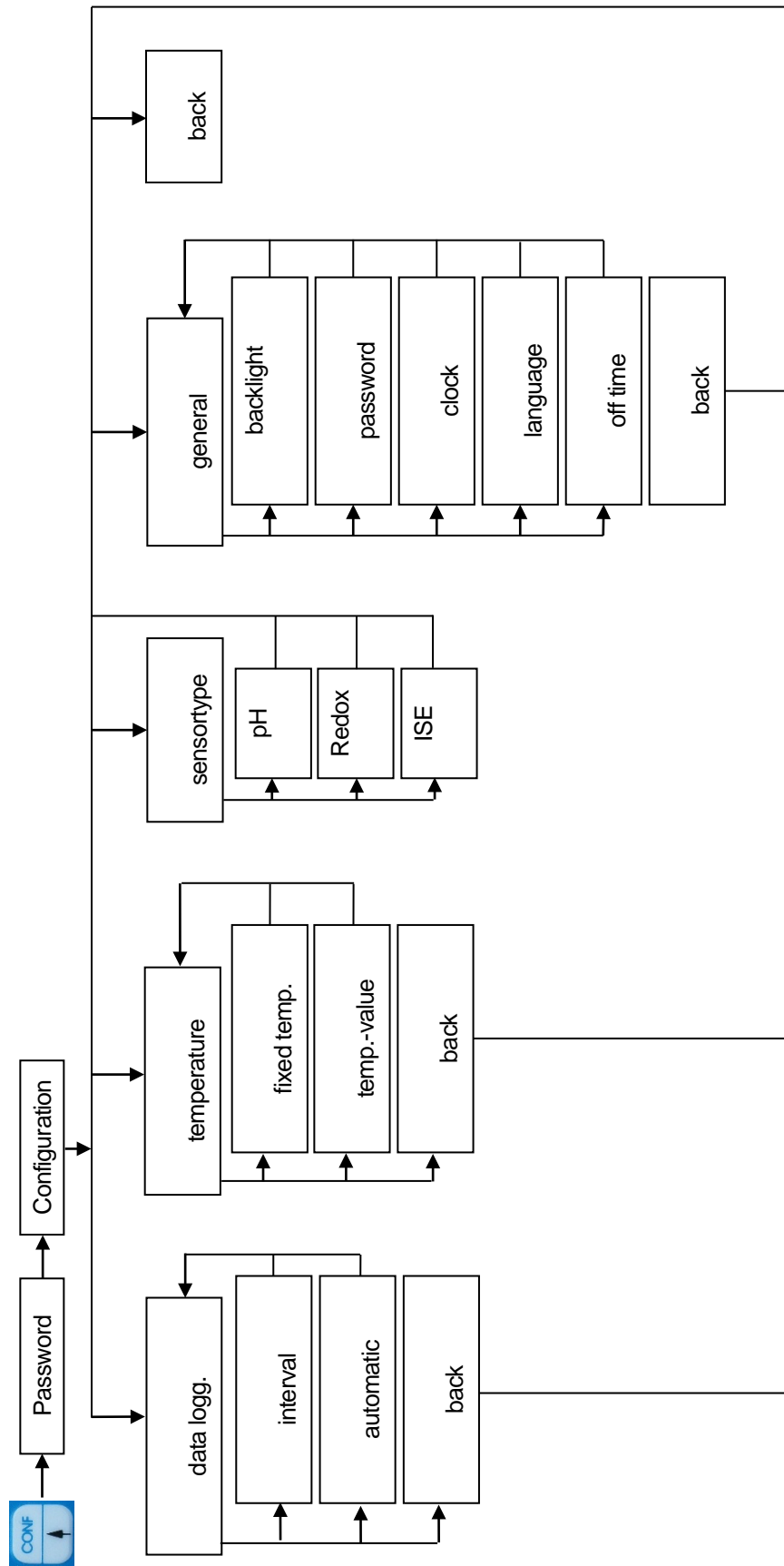

## 8.5 Calibration pH



Open with + password the calibration menu.

All kinds of calibration method will be displayed. Choose now your method.

Take note of temperature compensation for all calibration methods. This means, if measured values are compensated by temperature measurement, the associated temperature sensor must also be dipped into the calibration medium to be able to determine the exact temperature.

Carefully rinse electrode with distilled/deionized water after each measurement to avoid carrying off of the measuring medium and sluggish measurement.

The sensor will be dipped in the buffer solution. Wait until the value is stabilised.

### 8.5.1 Data input

Data input stands for the input of the specific values of the connected sensor, for example as determined at the laboratory before.

asymmetry  
slope  
back

Select the corresponding calibration value whose settings you want to change. An input dialogue will now enable you to change the values within corresponding limits. If you exceed these you will get an error message to prompt you to enter a value within the fixed limits.

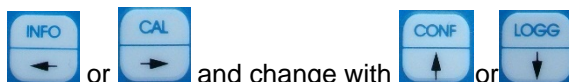

Select the position you would like to change by using the buttons or and change with or .



Press the -button to accept and save the entry.



To cancel the input dialogue without saving the value press + .

### 8.5.2 Settings of the temperature offset

This menu item enables you to set a temperature value offset. For this purpose open the menu item "temp. offs.". Now, an input dialogue will be displayed which facilitates the setting. The offset can be positive or negative.

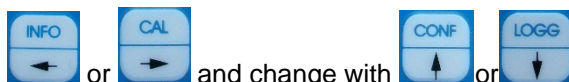

Select the position you would like to change by using the buttons or and change with or .



Press the -button to accept and save the entry.

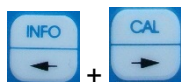

To cancel the input dialogue without saving the value press + .

### 8.5.3 Two-point-Calibration "two point"









Calibrate the sensor at two separate points using two different defined calibration solutions or known set point values. The calibration points are supposed to include the measuring range or the measured values to be expected, respectively. You can choose any sequence of the calibration solutions or set point values.



At first, you will be prompted to dip the sensor into the first calibration medium. After this step press to accept the dialogue. Now, the currently measured value will be displayed. After the measured value has attained a stable



state, press to accept the dialogue. You will now be prompted to enter the associated set point value.

Select the position you would like to change by using the buttons  or . Adjust the corresponding position with  (+1) or  (-1). Press the -button to accept and save the entry. To cancel the input dialogue without saving the value press  + . The next dialogue field will now prompt you to dip the sensor into the second calibration medium. After you have accepted this, the currently measured value will, again, be displayed. Press  again to accept the stabilised measured value, before you will be prompted to enter the associated set point value. As a result, you will now be given the new calibration values that will be save in the device.

## 8.5.4 Automatic Calibration

The automatic calibration of the pH measurement is a two-point type and requires knowledge of what buffer solution group you want to use. The TM 40 offers the following buffer solution groups for calibration:

NBS standard buffer solution as per DIN 19266:	pH value at 25 °C 1.68 / 4.01 / 6.86 / 9.18 / 12.45
Technical buffer solution as per DIN 19267:	pH value at 25 °C 1.09 / 3.06 / 4.65 / 6.79 / 9.23
Knick/Mettler-Toledo/Ingold buffer solution:	pH value at 25 °C 2.00 / 4.01 / 7.00 / 9.21
Laboratory buffer solution:	pH value at 25 °C 2.00 / 4.01 / 6.98 / 8.95 / 11.88

You must take a choice in the first dialogue box of the used buffer solutions. For further conditions and tips, please refer to the sensor specifications.

A subsequent dialogue will prompt you to dip the sensor into the first buffer solution. Press  to confirm. Now, the current measured value will be displayed. After the display shows a stabilised value, confirm this. Now, the same procedure as for the first buffer solution will follow (dip sensor into buffer solution 2, wait for value stabilisation) for the second one. As a result, you will now be given the new calibration values that will be save in the device.

## 8.5.5 Calibration error

In the TM 40 predefined ranges for the calibration values are stored. If the determined calibration value is out of the range the message **!Out of limit!** appears in the calibration information **CAL INFORMATION**. The determined calibration value will be stored nevertheless, so that the measuring and controlling is secured. In this case a new calibration or a replace of the sensor is necessary.

## 8.6 Calibration Redox

### 8.6.1 Data input

This menu item enables you to set a Redox value offset. Please see also para 8.4 → Redox.

### 8.6.2 Setting of the temperature offset

This menu item enables you to set a temperature value offset. Same procedure as pH temperature offset at para 8.5.2.





## 8.7 Calibration ISE

### 8.7.1 Data input



Data input stands for the input of the specific values of the connected sensor, for example as determined at the laboratory before.

Select the corresponding calibration value whose settings you want to change by. An input dialogue will now enable you to change the values within corresponding limits. If you exceed these you will get an error message to prompt you to enter a value within the fixed limits.

slope  
meas.val.  
input. Val.  
back

Select the position you would like to change by using the buttons  or  and change with  or .

Press the -button to accept and save the entry.

To cancel the input dialogue without saving the value press  + .

### 8.7.2 Settings of the temperature offset



This menu item enables you to set a temperature value offset.  
Same procedure as pH temperature offset at para 8.5.2.

### 8.7.3 Two-point Calibration „Two point“

Calibrate the sensor at two separate points using two different defined calibration solutions or known set point values. The calibration points are supposed to include the measuring range or the measured values to be expected, respectively. You can choose any sequence of the calibration solutions or set point values.

At first, you will be prompted to dip the sensor into the first calibration medium. After this step press  to accept the dialogue. Now, the currently measured value will be displayed. After the measured value has attained a stable

state, press  to accept the dialogue. You will now be prompted to enter the associated set point value.

Select the position you would like to change by using the buttons  or . Adjust the corresponding

position with  (+1) or  (-1). Press the -button to accept and save the entry. The next dialogue field will now prompt you to dip the sensor into the second calibration medium. After you have accepted this, the

currently measured value will, again, be displayed. Press  again to accept the stabilised measured value, before you will be prompted to enter the associated set point value. As a result, you will now be given the new

calibration values that will be save in the device. To cancel the input dialogue without saving the value press .

+ .

## 8.8 Configuration TM 40

Open with  + password the configuration menu.  
Select the menu item you would like to configuration.

data logg  
temperature  
sensortype  
general.  
back









### 8.8.1 Configuration of the fix temperature

For calculating the analysis parameter pH a temperature compensation is always necessary. For that the temperature of the measuring and of the calibration fluid must be measured or a fix temperature must be configured. If the fix temperature is activated this will be used for the temperature compensation. In this case the message **Fix** appears in the right upper display corner.

For configuration the fix temperature do the following steps:

1. open the menu „temperature“
2. activate / deactivate the fix temperature in the menu item „fixed temp.“
3. enter the fix temperature value in the menu item „ temp.-value“

Select the position you would like to change by using the buttons  or . Adjust the corresponding position with  (+1) or  (-1). Press the -button to accept and save the entry. To cancel the input dialogue without saving the value press  + .





### 8.8.2 Configuration of the sensor type

The TM 40 can be connected with pH, ORP or ISE electrodes. The used sensor type has to be configured in the device.

For configuration of a sensor type do the following steps:

1. open menu „sensortype“
2. select the type

pH  
Redox  
ISE

Select the position you would like to use by using the buttons  or . Press the -button to accept and save the entry. To cancel the input dialogue without saving the value press  + .

## 9. AM 40

### 9.1 Application Fields AM 40

The Oxygen Meter measures dissolved oxygen in accordance with the German standard methods for the examination of water, waste water and sludge DIN EN ISO 5814:2013 and combines the features for mobile application in the field with the precision and comfort of a laboratory meter. The meter is the ideal choice for determination of the oxygen content in surface water, sewage and for application in wastewater treatment. AM 40 features simultaneous measurement of oxygen and temperature, high measuring accuracy, multi function display, easy air calibration, integrated data logging system and a rugged watertight IP 65 enclosure.

### 9.2 Construction AM 40

AM 40/Set comes completely with the accompanying dissolved oxygen sensor MF 41-N/AM 40 and accessories in a protective case. This combination operates in accordance with the standardized requirements for determination of dissolved oxygen; electrochemical probe method acc. ISO 5814:1990 resp. German version DIN EN ISO 5814:2013. The instrument in connection with the sensor indicates the mass concentration of dissolved oxygen in aqueous solutions in mg/l and the oxygen saturation index in percent saturation as well as the relevant temperature simultaneously.

### 9.3 Dissolved Oxygen Sensor MF 41-N/AM 40

The MF 41 sensor is based upon the Clark principle as a polarographic sensor containing a Pt cathode as the working electrode and an Ag/AgCl anode as the counter electrode. Both electrodes inclusive the electrolyte are separated from the medium by a membrane. The membrane is permeable only to molecular oxygen, so that liquids, ions and solids are not able to reach the electrochemical cell. At a polarisation voltage of about 700 mV between platinum cathode and Ag/AgCl anode a current occurs. The oxygen molecules diffused through the membrane are reduced to hydroxyl ions (OH<sup>-</sup>) at the cathode. At the anode, the equivalent amount of silver is oxidized to AgCl. This causes a current depending on the oxygen partial pressure of the analysed medium.

The oxygen sensor consists of a shaft and a basic body inclusive the electrode system and the membrane head. The basic body made of stainless steel contains the platinum cathode, the Ag/AgCl anode and a built-in temperature sensor Pt 1000. The membrane head has an integrated polymeric membrane and is equipped with an optimally designed multi-layer membrane using a very durable and dirt repelling material. This features high accuracy and reliability as well as long time intervals for maintenance of the sensor.

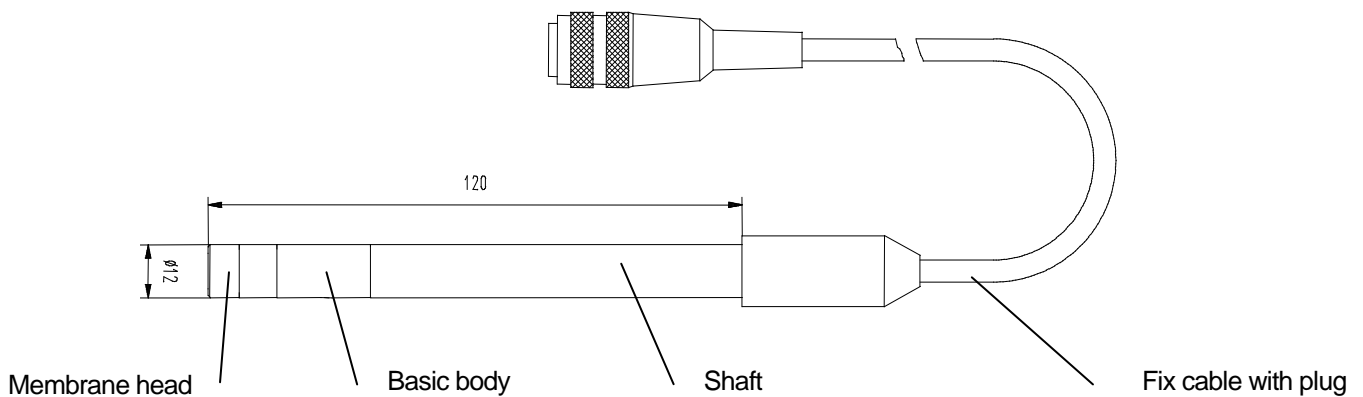

### 9.4 Menu structure AM 40

#### Menu structure Calibration

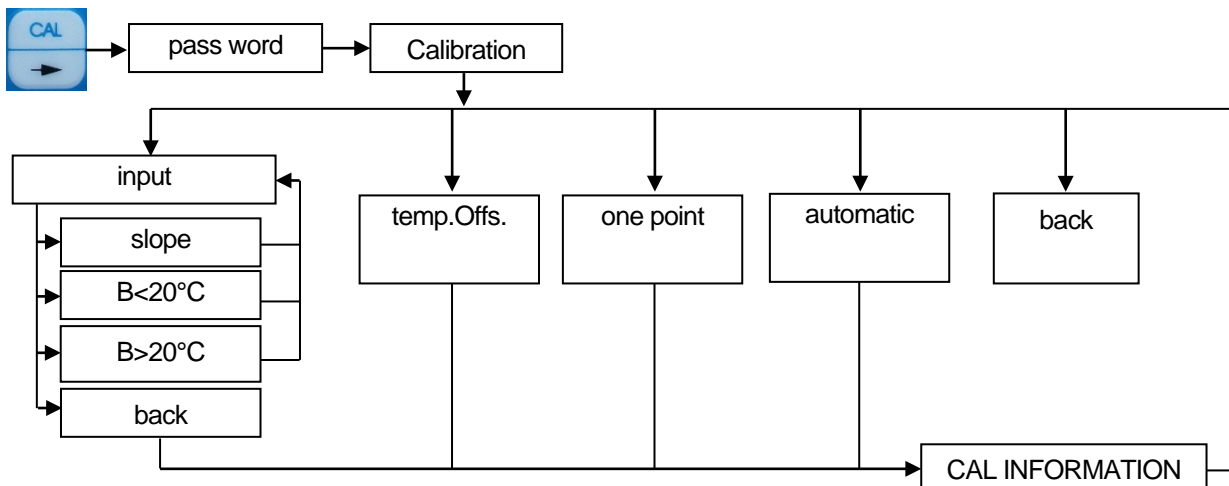

### Menu structure Configuration

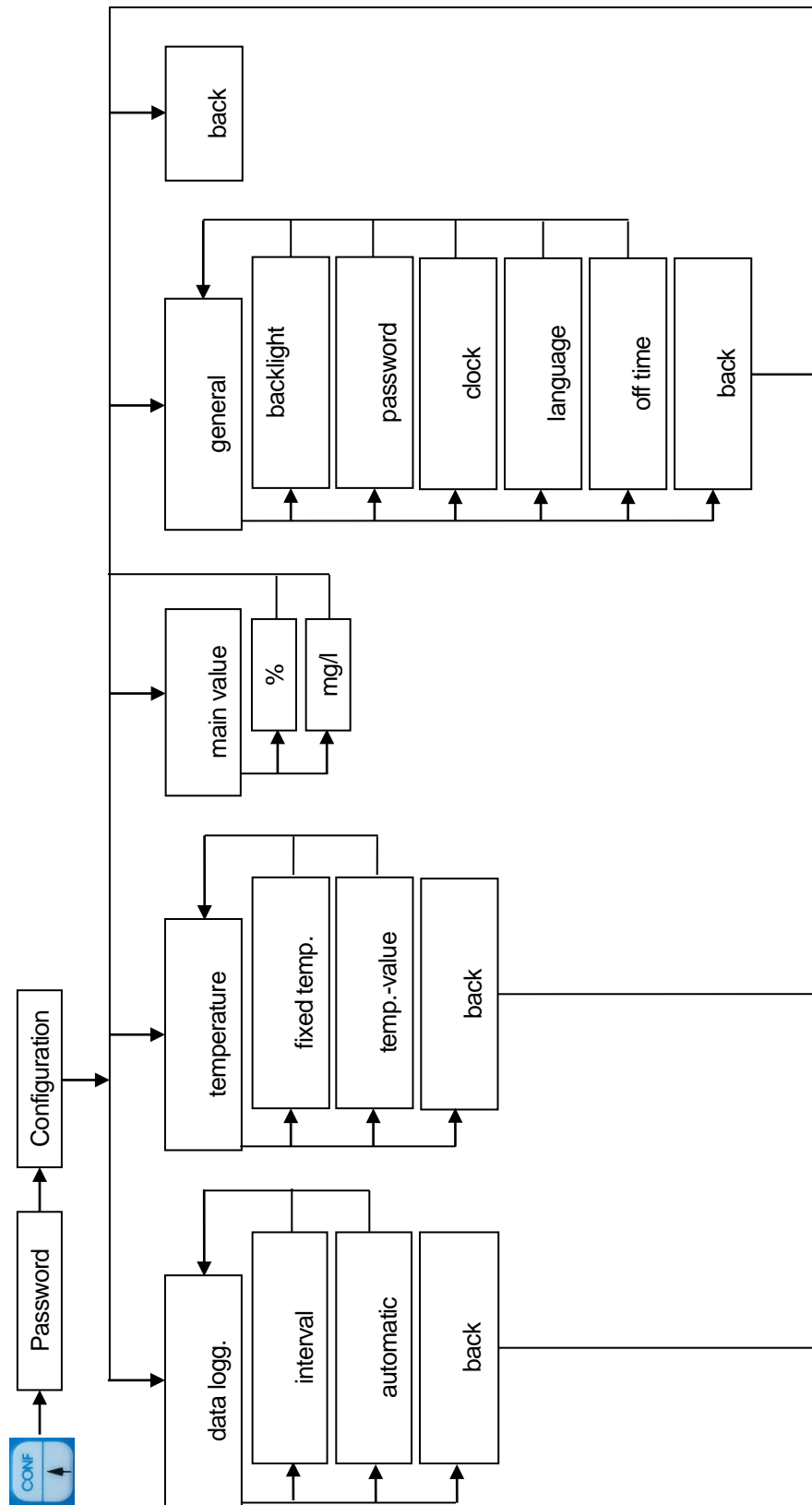

## 9.5 Calibration oxygen



Open with + password the calibration menu.





All kinds of calibration method will be displayed. Choose now your method.

Please take note for all calibration method the temperature compensation.



### 9.5.1 Data input

Data input stands for the input of the specific values of the connected sensor, for example as determined at the laboratory before.

Select the corresponding calibration value whose settings you want to change. An input dialogue will now enable you to change the values within corresponding limits. If you exceed these you will get an error message to prompt you to enter a value within the fixed limits.





Select the position you would like to change by using the buttons  or  and change with  or .

Press the  -button to accept and save the entry.



To cancel the input dialogue without saving the value press  + .

### 9.5.2 Settings of the Temperature Offset

This menu item enables you to set a temperature value offset. For this purpose open the menu item "temp.off". Now, an input dialogue will be displayed which facilitates the setting. The offset can be positive or negative.

Select the position you would like to change by using the buttons  or  and change with  or .

Press the  -button to accept and save the entry.





To cancel the input dialogue without saving the value press  + .

### 9.5.3 Single-Point Calibration „one point“

Calibrate the measuring signal at this one point using a defined calibration solution or a known set point value, e. g. determined by a separate method or by means of another laboratory/field instrument. At first, you will be prompted to dip the sensor into the corresponding calibration medium.

After this step press  to accept the dialogue. Now, the currently measured value will be displayed. After the

measured value has attained a stable state, accept the dialogue again by pressing . You will now be prompted to enter the set point value.

Select the position you would like to change by using the buttons  or  and change with  or .

Press the  -button to accept and save the entry. To cancel the input dialogue without saving the value press

 + .

As a result, you will now be given the new calibration values that will be save in the device.

### 9.5.4 Automatic Calibration

The automatic calibration of the oxygen content measurement is a single-point calibration in the ambient air up to 102%.

At first, you will be prompted to dip the sensor into the corresponding calibration medium (outside air).

After this step press  to accept the dialogue. Now, the currently measured value will be displayed. After the

measured value has attained a stable state, accept the dialogue again by pressing .

As a result, you will now be given the new calibration value that will be save in the device.

### 9.5.5 Calibration error

In each device predefined ranges for the calibration values are stored. If the determined calibration value is out of the range the message **!Out of limit!** appears in the calibration information **CAL INFORMATION**. The determined calibration value will be stored nevertheless, so that the measuring and controlling is secured. In this case a new calibration or a replace of the sensor / sensor part (membrane head, electrolyte) is necessary.

## 9.6 Configuration AM 40



Open with + password the configuration menu.  
Select the menu item you would like to configuration.

- data logg
- temperature
- main value
- general
- back

### 9.6.1 Configuration of the fix temperature

For calculating the analysis parameter O<sub>2</sub> a temperature compensation is always necessary. For that the temperature of the measuring and of the calibration fluid must be measured or a fix temperature must be configured. If the fix temperature is activated this will be used for the temperature compensation. In this case the message **Fix** appears in the right upper display corner.

For configuration the fix temperature do the following steps:

1. open the menu „temperature“
2. activate / deactivate the fix temperature in the menu item „fixed temp.“
3. enter the fix temperature value in the menu item „ temp.-value“

Select the position you would like to change by using the buttons or and change with or .

Press the -button to accept and save the entry.

To cancel the input dialogue without saving the value press + .

### 9.6.2 Configuration of the main value

It is possible to replace the main measuring value and the second measuring. If not different ordered in the factory-provided version the main measuring value is the oxygen saturation in % and the second measuring value is the oxygen concentration in mg/l.

For configuration of the main measuring value do the following steps:

1. open the menu „main value“
2. select the main measuring value

	main measuring value	second measuring value
%	oxygen saturation in %	oxygen concentration in mg/l
mg/l	oxygen concentration in mg/l	oxygen saturation in %

Select the position you would like to use by using the buttons or . Press the -button to accept

and save the entry. To cancel the input dialogue without saving the value press + .

## 10. LF 40

### 10.1 Application Fields LF 40

The LF 40 measures the electrical conductivity, the salinity and the temperature in accordance with the German standard methods for the examination of water, waste water and sludge and combines the features for mobile application in the field with the precision and comfort of a laboratory meter. LF 40 features simultaneous measurement of conductivity, temperature and salinity, high measuring accuracy, multi function display with plain text menu structure, integrated data logging system and a rugged watertight IP 65 enclosure.

### 10.2 Construction LF 40

LF 40/Set comes completely with the conductivity sensor LTC 0,35/LF 40 and accessories in a protective case. This combination operates in accordance with the standardized requirements for determination of conductivity; electrochemical probe method acc. EN ISO 27888:1993. The instrument in connection with the sensor indicates the conductivity in aqueous solutions in  $\mu\text{S}$  or  $\text{mS}$  as well as the relevant temperature simultaneously.

### 10.3 Conductivity Sensor LTC 0,35/LF 40

The Conductivity Cell LTC 0,35/LF 40 has a fixed cable connection to the meter with a length of 1.00 m and is ideal for general applications in laboratory and field. Two special graphite electrodes sealed in epoxy feature high mechanical stability, easy purification and low maintenance. A temperature sensor with low response time is integrated in the cell for automatic temperature compensation and parallel measurement.

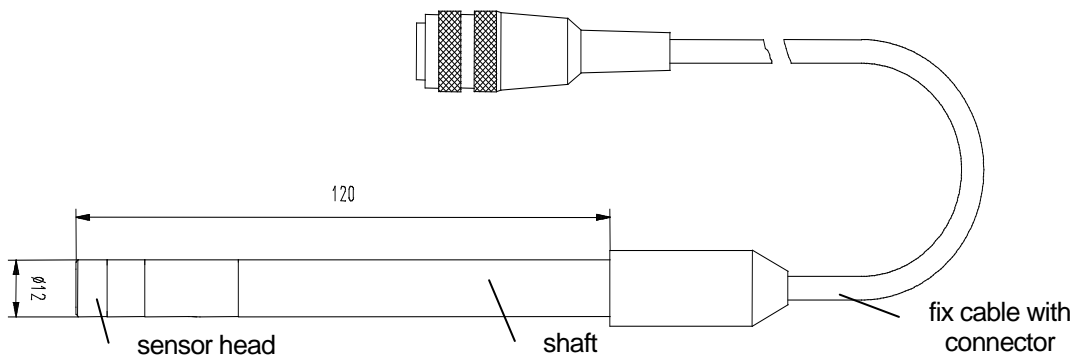

### 10.4 Menu structure LF 40

#### Menu structure Calibration

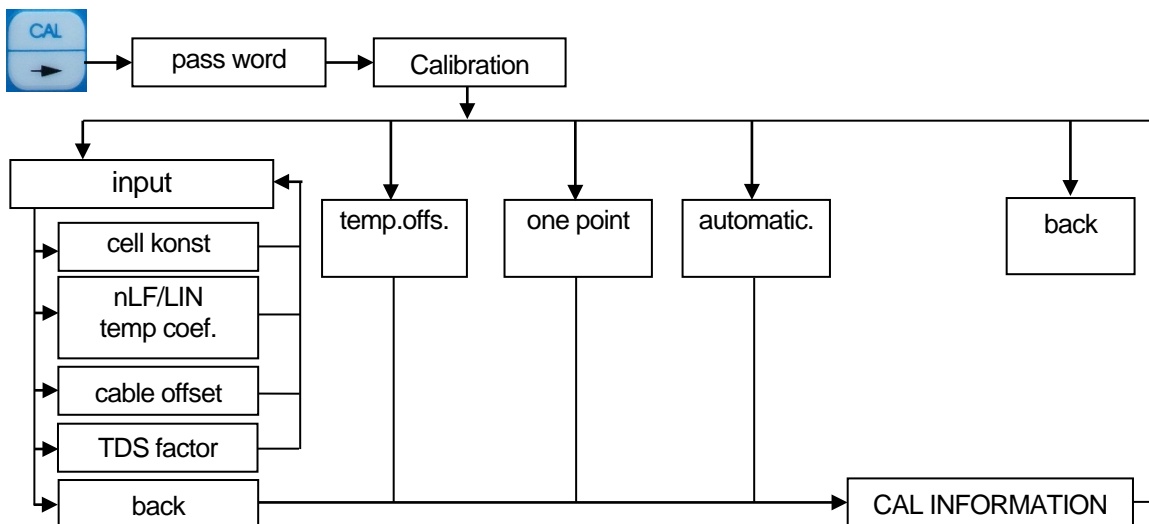

### Menu structure Configuration

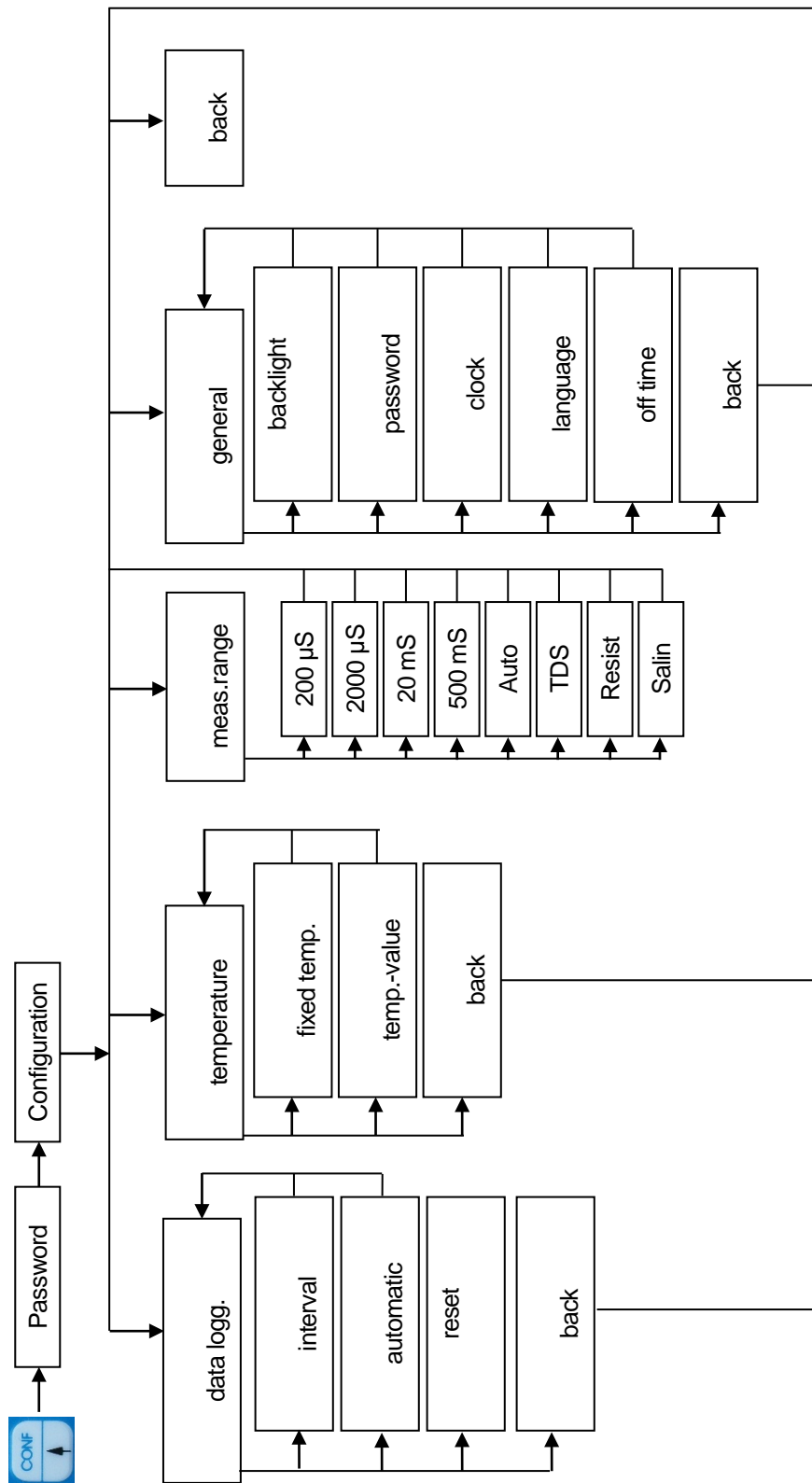

## 10.5 Calibration conductivity



Open with  + password the calibration menu.

All kinds of calibration method will be displayed. Choose now your method.

Take note of temperature compensation for all calibration methods. This means, if measured values are compensated by temperature measurement, the associated temperature sensor must also be dipped into the calibration medium to be able to determine the exact temperature.

Carefully rinse electrode with distilled/deionized water after each measurement to avoid carrying off of the measuring medium and sluggish measurement.

The Sensor will be dipped in the buffer solution. Wait until the value is stabilised.

### 10.5.1 Data input

Data input stands for the input of the specific values of the connected sensor, for example as determined at the laboratory before.

Select the corresponding calibration value whose settings you want to change. An input dialogue will now enable you to change the values within corresponding limits. If you exceed these you will get an error message to prompt you to enter a value within the fixed limits.

- cell const. → cell constant
- nLF/LIN temp coef. → temperature compensation + temperature coefficient
- cable offset. → cable offset
- TDS factor → TDS faktor
- back → back

Settings for temperature compensation:

**Lin:** Linear temperature compensation with adjustable temperature coefficient





**nLF:** non-linear temperature compensation for natural water according to DIN EN 27888.

**off:** For measuring without temperature compensation the temperature coefficient in **Lin must be set at „0 %/K“**.



☞ In Case of measurements with temperature compensation the conductivity value will be **calculated to the reference temperature of 25 °C**.

☞ The **salinity measuring** (second value) will be **calculated** every time regarding a **reference temperature of 15 °C** (according to IOT).

☞ For calculation of **TDS** (second value) the **nonlinear temperature compensation with a reference temperature of 25 °C** will be used every time.





Select the position you would like to change by using the buttons  or  and change with  or .

Press the  -button to accept and save the entry.



To cancel the input dialogue without saving the value press  + .

### 10.5.2 Settings of the temperature offset

This menu item enables you to set a temperature value offset. For this purpose open the menu item “temp.off.s.”. Now an input dialogue will be displayed which facilitates the setting. The offset can be positive or negative.

Select the position you would like to change by using the buttons  or  and change with  or .



Press the  -button to accept and save the entry.





To cancel the input dialogue without saving the value press  + .





### 10.5.3 One-point-Calibration „one point“

Calibrate the measuring signal at this one point using a defined calibration solution or a known set point value, e. g. determined by a separate method or by means of another laboratory/field instrument. At first, you will be prompted to dip the sensor into the corresponding calibration medium.

After this step press  to accept the dialogue. Now, the currently measured value will be displayed. After the measured value has attained a stable state, accept the dialogue again by pressing . You will now be prompted to enter the set point value.

Select the position you would like to change by using the buttons  or  and change with  or .

Press the  -button to accept and save the entry.

To cancel the input dialogue without saving the value press  + .



As a result, you will now be given the new calibration values that will be save in the device.

### 10.5.4 Automatic calibration „Automatic“

The automatic calibration of the conductivity measurement is a single-point calibration. The temperature-correction-curves for the following conductivity standard solutions are stored in the LF 40:

Conductivity Standard Solution 0,01 N KCl: 1,41 mS/cm (25 °C)  
Conductivity Standard Solution 0,1 N KCl: 12,9 mS/cm (25 °C)

At first, you will be prompted to dip the sensor into the corresponding calibration medium.

After this step press  to accept the dialogue. Now, the currently measured value will be displayed. After the measured value has attained a stable state, accept the dialogue again by pressing .

As a result, you will now be given the new calibration values that will be save in the device.

### 10.5.5 Calibration error

In each device predefined ranges for the calibration values are stored. If the determined calibration value is out of the range the message **!Out of limit!** appears in the calibration information **CAL INFORMATION**. The determined calibration value will be stored nevertheless, so that the measuring and controlling is secured. As the case a new calibration or a replace of the sensor is necessary.





## 10.6 Configuration

### 10.6.1 Configuration of the fix temperature

The analysis parameter conductivity can be calculated with a temperature compensation. For that the temperature of the measuring and of the calibration fluid must be measured or a fix temperature must be configured. If the fix temperature is activated this will be used for the temperature compensation, in this case the message **Fix** appears in the right upper display corner.

For configuration the fix temperature do the following steps:

1. open the menu „temperature“
2. activate / deactivate the fix temperature in the menu item „fixed temp.“
3. enter the fix temperature value in the menu item „ temp.-value“

Select the position you would like to change by using the buttons  or  and change with  or .



Press the -button to accept and save the entry.

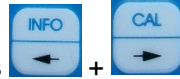

To cancel the input dialogue without saving the value press + .

### 10.6.2 Configuration of the measuring range „meas. range“

For measuring the conductivity in a proper accuracy the actual conductivity measuring range has to be configured. The useful measuring ranges depend on the cell constant and on the measuring cell used.

For configuration of the measuring range do the following steps:

1. open the menu „meas.range“
2. select the actual measuring range

- 0 ... 200 µS
- 0 ... 2000 µS
- 0 ... 20 mS
- 0 ... 500 mS

- Auto > automatically selects the correct range
- TDS > shows the calculated value as a by-value
- Resist > shows the calculated value as a by-value
- Salin > shows the calculated value as a by-value



Select the position you would like to change by using the buttons or . Press the -button to

accept and save the entry. To cancel the input dialogue without saving the value press + .

## 11. Specifications

<b>Configuration</b>	directly with the device by 5 Keys and Display (plain text menu structure) or by means of the PC interface and corresponding configuration program
<b>Display</b>	graphic LCD Display, 128 x 64 Pixel, backlight
<b>Interface</b>	USB with “Interface HMG USB”, isolated
<b>Power supply</b>	3 Batteries AA 1,5 V
<b>Ambient temperature</b>	-10 ... 55 °C
<b>Relative humidity</b>	max. <95 % (not condensing)
<b>Housing</b>	protection IP 65, dimensions 200 x 90 x 40 mm (L x W x H)
<b>Weight</b>	approx. 260 g (with battery)
<b>EMC</b>	acc. EN 61326 class B <ul style="list-style-type: none"> <li>ESD (EN 61000-4-2)             <ul style="list-style-type: none"> <li>Air: ±8 kV</li> <li>Contact: ±4 kV</li> <li>Criterion B</li> </ul> </li> <li>Radiated Radio frequency (EN 61000-4-3)             <ul style="list-style-type: none"> <li>Test level: 10 V/m</li> <li>Criterion A</li> </ul> </li> <li>Burst (EN 61000-4-4)             <ul style="list-style-type: none"> <li>I/O Signal: ±1 kV; 5/50 ns; 5 kHz</li> <li>Criterion B</li> </ul> </li> <li>Emissions standards (EN 55011)             <ul style="list-style-type: none"> <li>Radiated and conducted emission</li> <li>Class B</li> </ul> </li> </ul>
<b>Connectors</b>	connector BK for Sensor 4-pole USB Interface socket
<b>Housing</b>	ABS, IP 65
<b>Dimensions</b>	200 x 95 x 40 mm (B x H x T)
<b>Weight</b>	290 g incl. batteries

<b>Measuring range TM 40</b>	pH 0 ... 14, -1999 ... 1999 mV Temperature: -10 ... 100 °C
<b>Measuring range AM 40</b>	0 ... 200 %, 0 ... 20 mg/l Temperature: -10 ... 100 °C
<b>Measuring range LF 40</b>	0 ... 200 µS, TDS 0 ... 200 mg/l 0 ... 2000 µS, TDS 0 ... 2000 mg/l 0 ... 20 mS, TDS 0 ... 20 g/l 0 ... 500 mS, TDS 0 ... 500 g/l automatic range calculated resistance value calculated salinity value Temperature: -10 ... 100 °C

Recommended electrodes/sensors suitable for connection to the controller in accordance with the individual detailed technical data sheets.

## 12. Delivery volume

TM 40/Set	- pH- / Redox- / ISE- / temperature- pocket meter TM 40, incl. batteries - pH- / temperature- sensor EGA 142/TM 40 - case with accessories (buffer solution, KCl-solution) - Manual
TM 40	- pH- / Redox- / ISE- / temperature- pocket meter TM 40, incl. batteries - Manual - optional: case with accessories (buffer solution, KCl-solution)
AM 40/Set	- Oxygen- / temperature- pocket meter AM 40, incl. batteries - Oxygen- / temperature- sensor MF 41-N/AM 40 - case - Manual
AM 40	- Oxygen- / temperature- pocket meter AM 40, incl. batteries - Manual - optional: case
LF 40/Set	- Conductivity- / temperature- pocket meter LF 40, incl. batteries - Conductivity- / temperature- sensor LTC 0,35/LF 40 - case with accessories (calibration solution) - Manual
LF 40	- Conductivity- / temperature- pocket meter LF 40, incl. batteries - Manual - optional: case with accessories (calibration solution)

## 13. Accessories

A wide selection of electrodes and sensors with BK-connector are available.

<b>Interface HMG USB</b>	Interface cable for connecting USB
<b>DinModule</b>	PC-Software DinModule (for configuration and data transfer; CD-ROM) free download <a href="http://download.meinsberg.de/en/">http://download.meinsberg.de/en/</a>
<b>Protective cover</b>	Silicon-protective cover for pocked meter